

User Manual of Product 1:

Snow Joe 24V-X2-SB18 18-Inch 48-Volt 4-Ah Cordless Snow Blower, (2 x 4.0Ah Batteries and Charger)



CORDLESS SNOW BLOWER

OPERATOR'S MANUAL

A Division of Snow Joe®, LLC

Model 24V-X2-SB18

Form No. SJ-24V-X2-SB18-880E-M

IMPORTANT! Safety Instructions

All Operators Must Read These Instructions Before Use

Read all instructions when using cordless snow blowers. Basic safety precautions should always be followed to reduce the risk of fire, electric shock, and personal injury.

General Safety Rules

Notice the personal safety alert symbol  used in this manual to draw your attention to a **WARNING** given along with the particular operating instruction. This means that the operation requires special **ATTENTION, CAUTION, and AWARENESS**.

- **Keep work area clean and well lit** – Cluttered, dark areas invite accidents.
- **Keep bystanders away** – All bystanders and pets should be kept a safe distance away from the work area.
- **Dress properly** – Do not wear loose clothing or jewelry. They can get caught in moving parts. Protective rubber gloves and non-slip footwear are recommended when working outdoors.
- **Use the right product** – Do not use this machine for any job except that for which it is intended.
-  **CAUTION!** – Exercise caution to avoid slipping or falling. Wear protective footwear that will protect your feet and improve your footing on slippery surfaces.
- **Use safety glasses** – Also use safety footwear, snug-fitting clothing, protective gloves, hearing and head protection.
- **Do not force the snow blower** – Use the snow blower at the rate for which it was designed to ensure optimal performance and safe operation.
- **Stay alert** – Watch what you are doing. Use common sense. Do not operate the snow blower when you are tired or under the influence of alcohol or drugs.
- **Do not overreach** – Keep proper footing and balance at all times.
- **Store indoors** – When not in use, the snow blower should be kept dry and stored out of the reach of children in a high or locked place.
- **Maintain snow blower with care** – Follow instructions for lubricating and changing accessories.

 **WARNING!** Always disengage the switch lever and remove the battery pack before making any adjustments, inspecting, servicing, changing accessories, cleaning the snow blower, or when any other dangerous conditions are present. Any such operation should be performed after revolving parts inside the snow blower stop completely. Such preventive safety measures reduce the risk of starting the power tool accidentally.

 **WARNING!** When replacing any parts, you must strictly observe the instructions and procedures described in this user manual. Special care should be paid to any rubber parts, since these parts may increase the motor load and decrease its mechanical power if damaged.

 **WARNING!** If you notice that the snow blower is not running properly or hear abnormal sounds from the motor when it is in use, immediately stop the machine, disconnect the battery, and contact your service center.

- **Surfaces** – This snow blower is intended for use on paved surfaces. Do not use on gravel, stone or other unpaved surfaces unless the snow blower is adjusted for such surfaces according to the instructions given in the operator's manual.
- **Moving parts present risks** – Keep your face, hair, clothing, hands, and feet away from moving parts. All guards and safety attachments must be installed properly before using the unit. Shut off and disconnect the battery before touching any parts other than the handles and switch.
- **Avoid unintentional starting** – Make sure the safety switch and the switch lever are in the off position before inserting the battery in the unit. Do not carry the snow blower with the safety switch and the switch lever engaged.
- **Do not overreach** – Maintain proper footing and balance at all times. Place heels firmly on the ground and tightly grasp the handle bar. Watch for uneven surfaces and do not overreach. In case you fall or collide with the snow blower, inspect the unit for any damages or cracks. When stepping backwards, be careful to avoid obstacles beneath your feet or behind you to avoid falling.

 **WARNING!** If the snow blower strikes any object, follow these steps:

- i) Stop the snow blower. Remove the battery.
- ii) Inspect for damage.
- iii) Repair any damage before restarting and operating the snow blower.

Battery & Charger Safety Instructions

We pay a great deal of attention to the design of every battery pack to ensure that we supply you with batteries that are safe, durable and have a high energy density. The battery cells have a wide range of safety devices. Each individual cell is initially formatted and its electrical characteristic curves are recorded. This data is then used exclusively to be able to assemble the best possible battery packs.

Despite all the safety precautions, caution must always be exercised when handling batteries. The following points must be obeyed at all times to ensure safe use. Safe use can only be guaranteed if undamaged cells are used. Incorrect handling of the battery pack can cause cell damage.

IMPORTANT! Analyses confirm that incorrect use and poor care of high-performance batteries are the main factors responsible for personal and/or product damage.

⚠️ WARNING! Read all safety warnings and instructions. Failure to follow the warnings and instructions may result in electric shock, fire and/or serious injury

⚠️ WARNING! Use only approved replacement batteries; other batteries may damage the snow blower and cause it to malfunction.

⚠️ CAUTION! To reduce the risk of injury, charge the 24V iON+ lithium-ion battery packs only in their designated 24V iON+ lithium-ion charger. Other types of chargers present risk of fire, personal injury and damage. Do not wire a battery pack to a power supply plug or car cigarette lighter. Such misuse will permanently disable or damage the battery pack.

- **Avoid dangerous environments** – Do not charge the battery pack in rain, snow or in damp or wet locations. Do not use the battery pack or charger in the presence of explosive atmospheres (gaseous fumes, dust or flammable materials) because sparks may be generated when inserting or removing the battery pack, which could lead to a fire.
- **Charge in a well-ventilated area** – Do not block the charger vents. Keep them clear to allow for proper ventilation. Do not allow smoking or open flames near a charging battery pack. Vented gases may explode.

NOTE: The safe temperature range for the battery is -4°F – 113°F (-20°C – 45°C). Do not charge the battery outside in freezing weather; charge it at room temperature.

- **Maintain charger cord** – When unplugging the charger, pull the plug, not the cord, from the receptacle to reduce the risk of damage to the electrical plug and cord. Never carry the charger by its cord or yank it by the cord to disconnect it from the receptacle. Keep the cord away from heat, oil and sharp edges. Make sure the cord will not be stepped on, tripped over or subjected to damage or stress when the charger is in use. Do not use the charger with a damaged cord or plug. Replace a damaged charger immediately.

- **Do not use an extension cord unless it is absolutely necessary** – Using the wrong, damaged or improperly wired extension cord poses a risk of fire and electric shock. If an extension cord must be used, plug the charger into a properly wired 16 gauge or larger extension cord with the female plug matching the male plug on the charger. Make sure that the extension cord is in good electrical condition.
- **Charger 24VCHRG-DPC is rated for 120 volt AC only** – The charger must be plugged into an appropriate receptacle.
- **Use only recommended attachments** – Use of an attachment not recommended or sold by the battery charger or battery pack manufacturer may result in risk of fire, electric shock or personal injury.
- **Unplug charger when not in use** – Make sure to remove battery packs from unplugged chargers.

⚠️ WARNING! To reduce the risk of electric shock, always unplug the charger before performing any cleaning or maintenance. Do not allow water to flow into the charger. Use a Ground Fault Circuit Interrupter (GFCI) to reduce shock hazards.

- **Do not burn or incinerate battery packs** – Battery packs may explode, causing personal injury or damage. Toxic fumes and materials are created when battery packs are burned.
- **Do not crush, drop or damage battery packs** – Do not use the battery pack or charger if they have sustained a sharp blow, been dropped, run over or have been damaged in any way (i.e. pierced with a nail, hit with a hammer, stepped on, etc.).
- **Disconnect the battery pack from the appliance before making any adjustments, changing accessories, or storing appliance** – Such preventive safety measures reduce the risk of starting the appliance accidentally.
- **Avoid unintentional starting** – Make sure the safety switch and the switch lever are in the off position before inserting the battery in the unit. Do not carry the snow blower with the safety switch and the ON/OFF trigger engaged.
- **When battery pack is not in use, keep it away from other metal objects** – like paper clips, coins, keys, nails, screws or other small metal objects that can make a connection from one terminal to another. Shorting the battery terminals together may cause burns or a fire.
- **Under abusive conditions, liquid may be ejected from the battery; avoid contact** – If contact accidentally occurs, flush with water. If liquid contacts eyes, additionally seek medical help. Liquid ejected from the battery may cause irritation or burns.
- **Do not use a battery pack or appliance that is damaged or modified** – Damaged or modified batteries may exhibit unpredictable behavior resulting in fire, explosion or risk of injury.
- **Do not expose a battery pack or appliance to fire or excessive temperature** – Exposure to fire or temperature above 130°C (265°F) may cause explosion.

- **Follow all charging instructions and do not charge the battery pack or appliance outside of the temperature range specified in the instructions** – Charging improperly or at temperatures outside of the specified range may damage the battery and increase the risk of fire.
 - **Have servicing performed by a qualified repair person using only identical replacement parts** – This will ensure that the safety of the product is maintained.
 - **Do not modify or attempt to repair the appliance or the battery pack** – (as applicable) except as indicated in the instructions for use and care.
 - **Do not disassemble** – Incorrect reassembly may pose a serious risk of electric shock, fire or exposure to toxic battery chemicals. If the battery or charger are damaged, please contact an authorized Snow Joe® + Sun Joe® dealer or call the Snow Joe® + Sun Joe® customer service center at 1-866-SNOWJOE (1-866-766-9563).
 - **Battery chemicals cause serious burns** – Never let a damaged battery pack contact the skin, eyes or mouth. If a damaged battery pack leaks battery chemicals, use rubber or neoprene gloves to safely dispose of it. If skin is exposed to battery fluids, wash the affected area with soap and water and rinse with vinegar. If eyes are exposed to battery chemicals, immediately flush with water for 20 minutes and seek medical attention. Remove and dispose of contaminated clothing.
 - **Store your battery pack and charger in a cool, dry place** – Do not store the battery pack or charger where temperatures may exceed 104°F (40°C), such as in direct sunlight or inside a vehicle or metal building during the summer.
8. Protect the battery and the tool from overloads. Overloads will quickly result in overheating and cell damage inside the battery housing even if this overheating is not apparent externally.
 9. Avoid damage and shocks. Immediately replace batteries that have been dropped from a height of more than one meter or those that have been exposed to violent shocks, even if the housing of the battery pack appears to be undamaged. The battery cells inside the battery may have suffered serious damage. In such instances, please read the waste disposal information for proper battery disposal.
 10. If the battery pack suffers overloading and overheating, the integrated protective cutoff will switch off the equipment for safety reasons. If this situation happens, stop the tool and let the battery cool down for a few minutes before restarting.

IMPORTANT! Do not press the ON/OFF trigger any more if the protective cut-off has been activated. This may damage the battery pack.
 11. Use only original battery packs. The use of other batteries poses a fire risk and may result in injuries or an explosion.

Information about the charger and the charging process

Information about the battery

1. The battery packs supplied with your cordless snow blower are only partially charged. The battery packs have to be charged completely before you use the tool for the first time.
2. For optimum battery performance, avoid low discharge cycles by charging the battery pack frequently.
3. Store the battery pack in a cool place, ideally at 59°F (15°C) and charged fully.
4. Lithium-ion batteries are subject to a natural aging process. The battery pack must be replaced at the latest when its capacity falls to just 80% of its capacity when new. Weakened cells in an aged battery pack are no longer capable of meeting the high power requirements needed for the proper operation of your snow blower, and therefore pose a safety risk.
5. Do not throw battery packs into an open fire as this poses a risk of explosion.
6. Do not ignite the battery pack or expose it to fire.
7. Do not exhaustively discharge batteries. Exhaustive discharge will damage the battery cells. The most common cause of exhaustive discharge is lengthy storage or non-use of partially discharged batteries. Stop working as soon as the performance of the battery falls noticeably or the electronic protection system triggers. Place the battery pack in storage only after it has been fully charged.
8. Never use or charge batteries if you suspect that it has been more than 12 months since the last time they were charged. There is a high probability that the battery pack has already suffered dangerous damage (exhaustive discharge).

9. Charging batteries at a temperature below 41°F (5°C) will cause chemical damage to the cells and may cause a fire.
10. Do not use batteries that have been exposed to heat during the charging process, as the battery cells may have suffered dangerous damage.
11. Do not use batteries that have suffered curvature or deformation during the charging process or those that exhibit other atypical symptoms (gassing, hissing, cracking, etc.)
12. Never fully discharge the battery pack (maximum recommended depth of discharge is 80%). A complete discharge of the battery pack will lead to premature aging of the battery cells.

Protection from environmental influences

1. Wear suitable work clothes. Wear safety goggles.
2. Protect your cordless tool and the battery charger from moisture and rain. Moisture and rain can cause dangerous cell damage.
3. Do not use the cordless tool or the battery charger near vapors and flammable liquids.
4. Use the battery charger and cordless tools only in dry conditions and at an ambient temperature of 50°F – 104°F (10°C – 40°C).
5. Do not keep the battery charger in places where the temperature is liable to reach over 105°F (40.5°C). In particular, do not leave the battery charger in a car that is parked in the sunshine.
6. Protect batteries from overheating. Overloads, overcharging and exposure to direct sunlight will result in overheating and cell damage. Never charge or work with batteries that have been overheated – replace them immediately, if possible.
7. Store the charger and your cordless tool only in dry locations with an ambient temperature of 50°F – 104°F (10°C – 40°C). Store your lithium-ion battery pack in a cool, dry place at a temperature of 50 – 68°F (10 – 20°C). Protect the battery pack, charger and cordless tool from humidity and direct sunlight. Only place fully charged batteries in storage.
8. Prevent the lithium-ion battery pack from freezing. Battery packs that were stored below 32°F (0°C) for more than 60 minutes must be discarded.
9. When handling batteries, be wary of electrostatic charge. Electrostatic discharges can damage the electronic protection system and the battery cells. Avoid electrostatic charging and never touch the battery poles.

Additional Safety Instructions

Safety Instructions for Walk-Behind Snow Blowers

- **Read the operator's manual carefully** – Learn your snow blower's applications and limitations as well as the specific potential hazards related to this machine. Do not use this machine for any purpose other than the one for which it was designed. Failure to adhere to these precautions may cause mechanical defaults, serious damage, or personal injury.
- **Preliminary unit inspection** – Thoroughly inspect the unit before use. Make sure all the parts are secure and installed correctly. If you notice any abnormalities, do not use the machine until it has been properly repaired. Always perform a test run the first time you use the snow blower or after replacing parts to ensure that the unit is functioning properly.
- **Preliminary area inspection** – Clear the area to be plowed before each use. Remove all objects such as rocks, broken glass, nails, wire, or string, which can be thrown by or become entangled in the snow blower. Keep the area of operation clear of all people, children, and pets.
- **Excessive force** – The snow blower was designed to respond at a certain rate for various snow conditions for optimal safety and performance. Do not force it; keep the applied pressure constant throughout its operation.
- **Malfunctioning switch** – Do not use the snow blower if the switch does not turn it on and off. Any appliance that cannot be controlled by the switch is not safe to use and must be repaired.
- **Hitting an object** – If the snow blower accidentally strikes an object, first stop the snow blower and remove the battery; next, inspect for damage; finally, repair or replace any damaged part before restarting and operating the snow blower.
- **Discharge chute safety** – Never direct the snow discharge chute at the operator, at bystanders, at vehicles, or at windows. The discharged snow, which may contain foreign objects accidentally picked up by the snow blower, can cause serious damage and personal injury. Do not use your hands to unclog the discharge chute. Stop the motor before removing debris.
- **Hand-held operating position** – Operation of the snow blower in the hand-held position is unsafe.
- **Abnormal operation** – If you find that the snow blower is not running properly or hear abnormal sounds or feel abnormal vibrations from the motor, immediately stop the machine, remove the battery, and contact an authorized Snow Joe® + Sun Joe® dealer or call the Snow Joe® + Sun Joe® customer service center at 1-866-SNOWJOE (1-866-766-9563) for assistance.
- **Noise control** – When using the snow blower, respect the local laws and regulations regarding noise control and environmental protection. To avoid noise disturbance, you should carefully decide upon an appropriate operation time and consider the surrounding conditions.

- **When work is completed** – Remove the battery pack from the snow blower when not in use, when changing accessories, and before performing any maintenance task.
- **Store safely** – Store the snow blower indoors in a dry area between uses. Keep in a locked area, where children and unauthorized users cannot gain access. Never store the snow blower with the battery pack installed. It may cause damage and injury.
- **Maintain for safety and longevity** – Check for misalignment or binding of moving parts, breakage of parts, and any other conditions that may affect the unit's operation. If damaged, repair or replace the damaged part before use. Use only those replacement parts made for your model. When replacing any parts, you must strictly observe the instructions and procedures described in this manual. Special care should be paid to any rubber parts, since these parts may increase the motor load and decrease its mechanical power if damaged.
- **Rotating parts** – Do not put hands or feet near or under rotating parts. Keep clear of the discharge opening at all times.
- **Hidden hazards** – Exercise extreme caution when operating on or crossing gravel drives, walks, or roads. Stay alert for hidden hazards or traffic.
- Exercise extreme caution when operating on slopes. Never operate the machine at high transport speeds on slippery surfaces. Look behind and use care when operating in reverse.
- Never operate the snow thrower without good visibility or light. Always be sure of your footing, and keep a firm hold on the handles. Walk; never run.
- Do not overload the machine capacity by attempting to clear snow at too fast a rate.
- Never allow children to operate the equipment. Never allow adults to operate the equipment without proper instruction.
- Adjust the collector housing height to clear gravel or crushed rock surface.
- Always wear safety glasses or eye shields during operation or while performing an adjustment or repair to protect eyes from foreign objects that may be thrown from the machine.

Electrical Safety

- **Avoid accidental starting** – Make sure the safety switch and the ON/OFF trigger is in the OFF position before inserting the battery pack into the unit. Do not carry the snow blower with the safety switch and ON/OFF trigger engaged.

Clearing a Clogged Discharge Chute















Hand contact with the rotating impeller inside the discharge chute is the most common cause of injury associated with snow throwers. Never use your hand to clean out the discharge chute.

To clear the chute:

- i) SHUT THE MOTOR OFF!
- ii) Wait 10 seconds to be sure the impeller blades have stopped rotating.
- iii) Always use a clean-out tool, not your hands.

Safety Symbols

The following table depicts and describes safety symbols that may appear on this product. Read, understand and follow all instructions on the machine before attempting to assemble and operate.

Symbols	Descriptions	Symbols	Descriptions
	READ THE OPERATOR'S MANUAL(S) – Read, understand and follow all instructions in the user manual(s) before attempting to assemble and operate.		WARNING! Do not expose the unit to rain or wet conditions. Keep dry.
	SAFETY ALERT – Indicates a precaution, a warning or a danger.		DANGER! Cutting/dismemberment hazard - Keep feet away from the rotating auger.
	Wear hearing protection. Wear eye protection. Wear breathing protection.		CAUTION! Beware of stones and other foreign objects that could be thrown from the appliance.
	Keep hands, feet and clothing away from the rotating auger to avoid injury.		The rotating part will continuously run for several seconds after you turn off the machine.
	Wear protective gloves and non-slip footwear when using the machine and handling debris.		Keep bystanders and children a safe distance (at least 33 ft/10 m) away from the work area.
	Do not use hands to unclog chute.		DANGER! Cutting/dismemberment hazard – Keep hands away from the rotating auger. Do not use hands to unclog rotor housing. Stop motor before removing debris.
	WARNING! Always turn the machine OFF and remove the safety key before conducting inspection, cleaning and maintenance.		Indoor use only. Only use battery charger indoors.

Know Your Cordless Snow Blower

Read the owner's manual and safety rules carefully before operating your cordless snow blower. Compare the illustration below to the actual unit in order to familiarize yourself with the location of the various controls and adjustments. Save this manual for future reference.

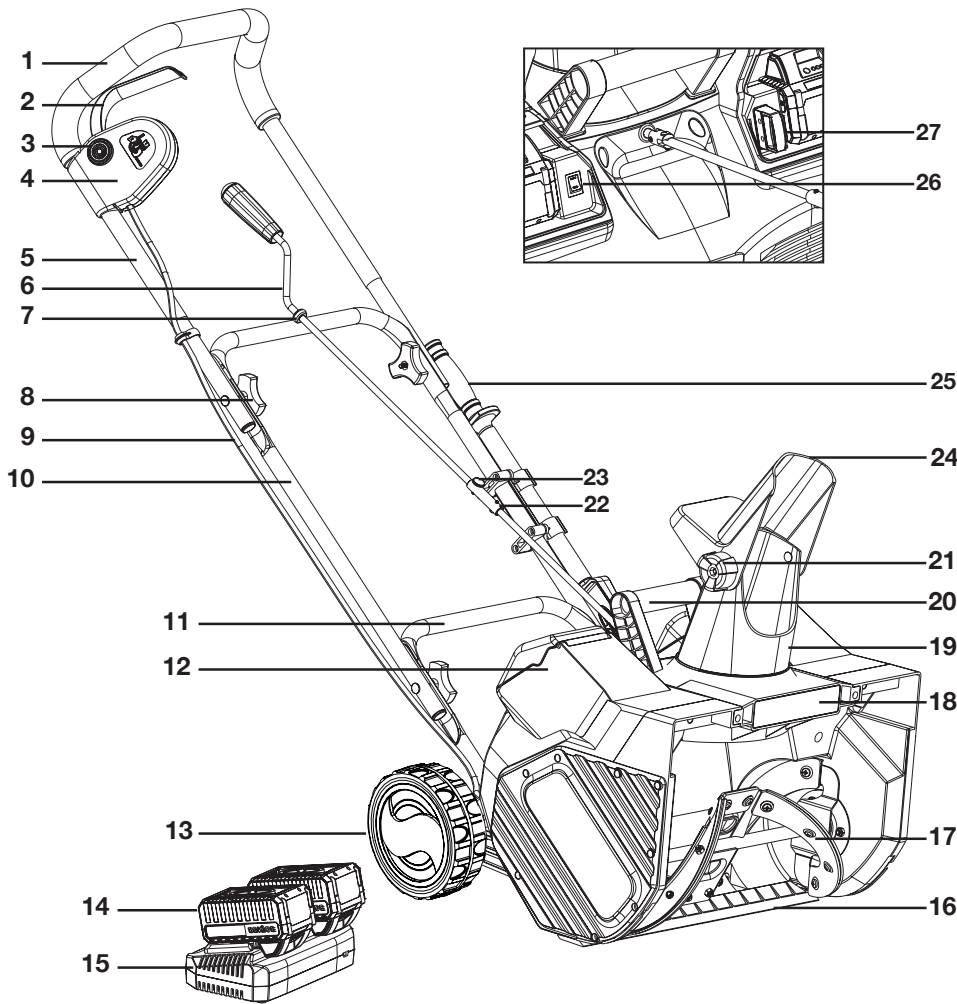

1. Handle bar
2. ON/OFF trigger
3. Safety lock button
4. Switch box
5. Upper frame
6. Upper crank rod
7. Rubber ring
8. Handle knobs and bolts (4)
9. Cord
10. Middle frame
11. Lower frame
12. Battery compartment (2)
13. Wheel (2)
14. 24V iON+ lithium-ion battery (24VBAT) featuring exclusive EcoSharp® technology (2)
15. 24V lithium-ion charger (24VCHRG-DPC)
16. Scraper bar
17. Auger
18. LED light
19. Discharge chute
20. Auxiliary handle
21. Deflector knob
22. Crank rod connector
23. Thumbscrew
24. Chute deflector
25. Clean out tool
26. Light switch
27. Safety key

Technical Data

Battery Voltage*	2 x 24 V D.C.	Depth of Snow Cut	10 in. (25.4 cm)
Battery Capacity	4.0 Ah	Throw Distance Max	20 ft (6 m)
Battery Runtime Max	40 min	Plowing Capacity Max	14 tons/charge (12.7 metric tons/hr)
Charging Time	1 hr 50 mins	Stages	Single stage
Charger Input	120 V AC, 60 Hz, 160 W	Type of Snow	Light, fluffy
Charger Output	26 V DC, 2.2 A (2 port)	Directional Control	180° chute
No Load Speed	2,500 rpm	LED Light	2 W
Auger	4 rubber-tipped steel blades	Tire size	6.5 in (16.5 cm)
Motor	1200 W Brushless	Weight (without battery)	34 lbs (15.4 kg)
Clearing Width	18 in. (46 cm)	Weight (with battery)	37.5 lbs (17 kg)

*Generates 48 V max with two 24 V lithium-ion batteries. Initial no-load voltage, per fully charged battery, peaks at 24 V. Nominal voltage under typical load is 21.6 V.

Unpacking

Carton Contents:

- Cordless snow blower
- Joint-fixing knob and bolt (4)
- Safety key
- Upper crank rod (assembled)
- Clean out tool (assembled)
- 24V iON+ lithium-ion battery (2)
- 24V iON+ lithium-ion dual port charger
- Manual(s) with registration card

1. Carefully remove the cordless snow blower and check to see that all of the above items are supplied.
2. Inspect the product carefully to make sure no breakage or damage occurred during shipping. If you find damaged or missing parts, DO NOT return the unit to the store. Please call the Snow Joe® + Sun Joe® customer service center at 1-866-SNOWJOE (1-866-766-9563).

NOTE: Do not discard the shipping carton and packaging material until you are ready to use the electric snow thrower. The packaging is made of recyclable materials. Properly dispose of these materials in accordance with local regulations or save the packaging for long-term product storage.

IMPORTANT! The equipment and packaging material are not toys. Do not let children play with plastic bags, foils or small parts. These items can be swallowed and pose a suffocation risk!

Battery Pack Operation

The equipment is powered by 2 lithium-ion batteries. The battery packs are completely sealed and maintenance free.





⚠ WARNING! The cordless snow blower can only be powered by both of the batteries together. One battery cannot provide sufficient power to the tool. Make sure to use two batteries of the same voltage and the same capacity. Using the tool with batteries of different capacity will cause damage to the batteries.

Battery Charge Level Indicator

The battery packs are equipped with a push button for checking the charge level. Simply press the push button to read off the battery charge level from the LEDs of the battery indicator:

- All 3 level monitoring LEDs are lit: Battery charge level is high.
- 2 level monitoring LEDs are lit: Battery charge level is decreasing. Stop work as soon as possible.

- 1 level monitoring LED is lit: Battery is flat. Stop work IMMEDIATELY and charge the battery. Otherwise the battery's service life will be greatly shortened.

Lights	Light Indicators
	
	Charge level button
	The battery is at 30% capacity and requires charging
	The battery is at 60% capacity and requires charging soon
	The battery is at full capacity

NOTE: If the charge level button does not appear to be working, place the battery pack on the charger and charge as needed.

NOTE: Immediately after using the battery packs, the charge level button may display a lower charge than it will if checked a few minutes later. The battery cells "recover" some of their charge after resting.

Charger Operation

⚠ WARNING! Charge only 24V iON+ lithium-ion battery packs with its compatible 24V iON+ lithium-ion charger. Other types of batteries may cause personal injury and damage.

To reduce the risk of electric shock, do not allow water to flow into the charger's AC/DC plug.

When to Charge the iON+ 24VBAT Lithium-iON Batteries

NOTE: The iON+ 24VBAT lithium-ion battery packs do not develop a "memory" when charged after only a partial discharge. Therefore, it is not necessary to run down the battery pack before inserting the charger plug.

- Use the battery indicator lights to determine when to charge your iON+ 24VBAT lithium-ion battery packs.
- You can "top-off" your battery pack's charge before starting a big job or after a long day of use.

Charging the Batteries

1. Press the push lock buttons on the batteries to pull them out of the equipment (Fig. 1).

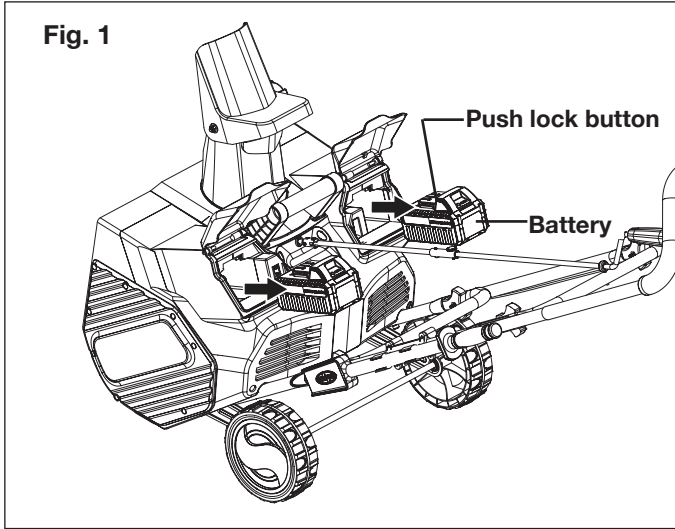

2. Check that the mains voltage is the same as that marked on the rating plate of the battery charger. Then, insert the charger's plug into the electrical wall outlet. When you plug in the charger, two green lights will illuminate and stay green (Fig. 2).

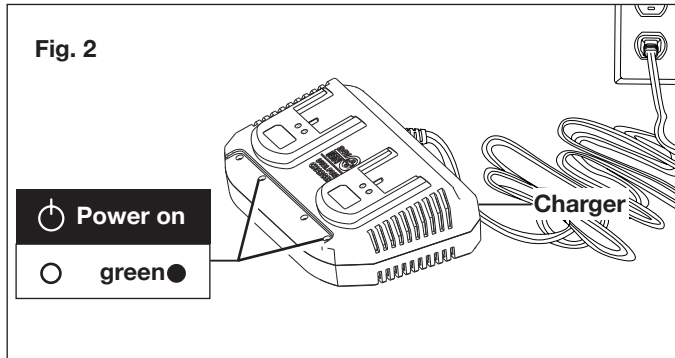

3. Place the battery packs into the charger by sliding the packs to lock them into position. When you insert the batteries into the charger, the two green lights will go off, and the red lights will illuminate to indicate that the batteries are charging (Fig. 3).

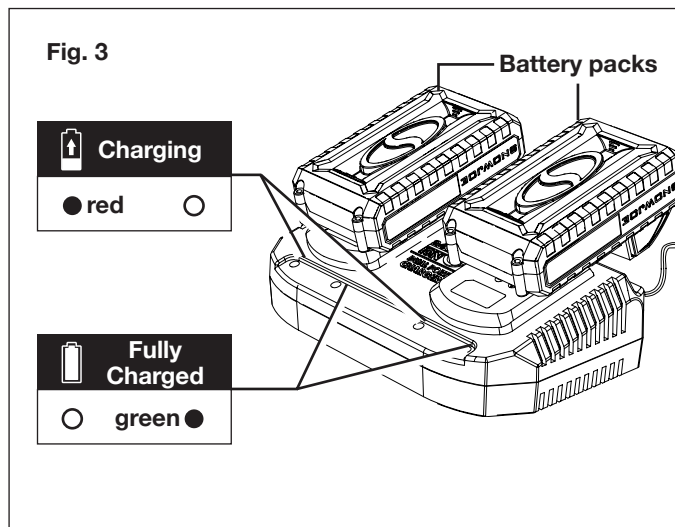

4. When the charger lights turn green, the batteries are fully charged (Fig. 3).

NOTE: A fully discharged pack with an internal temperature in the normal range will fully charge in 1 hrs and 50 mins (between 32°F/0°C and 113°F/45°C).

5. If the light indicators do not come on at all, check that the battery packs are fully seated into the bay. Remove the battery packs and reinsert. If the problem persists, contact an authorized Snow Joe® + Sun Joe® dealer or call the Snow Joe® + Sun Joe® customer service center at 1-866-SNOWJOE (1-866-766-9563) for assistance.
6. When charging is complete, remove the batteries from the charger by pressing the push lock buttons and sliding the batteries backward to unlock them from the charger (Fig. 4).

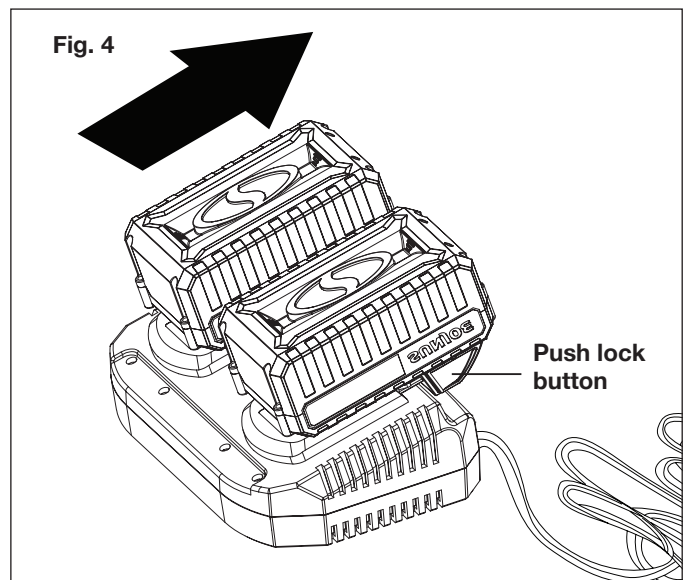

7. Timely recharging of the batteries will help prolong the batteries' life. You must recharge the battery packs when you notice a drop in the equipment's power.

IMPORTANT! Never allow the battery packs to become fully discharged as this will cause irreversible damage to the batteries.

Charging a Hot or Cold Battery Pack

The green indicator lights on the charger base indicates that the battery pack temperatures are outside the charging range. Once the pack are within the acceptable range, normal charging will take place and the red light will be continuous. Hot or cold battery packs may take longer to charge.

Lithium-Ion Charging Status			
Battery Pack Temperature	Charger Base Indicator Light	Battery Pack Indicator Light	Charging Status
Too hot	Green	Flashing together	Not charging
Normal range	Red	Flashing one by one	Normal charging
Too cold	Green	Flashing together	Not charging

Assembly

Assembling the handles

1. For easy assembly, the unit comes complete with most parts already connected. To complete the handle assembly, simply pull the middle frame back and pull the upper frame up (Fig. 5).

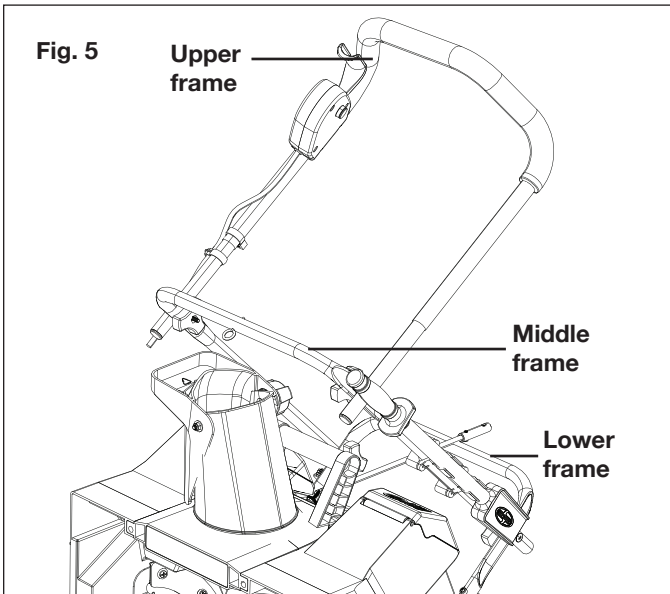

2. Secure the connection of the middle frame to the lower frame by fastening the first set of knobs and bolts on each side (Fig. 6).

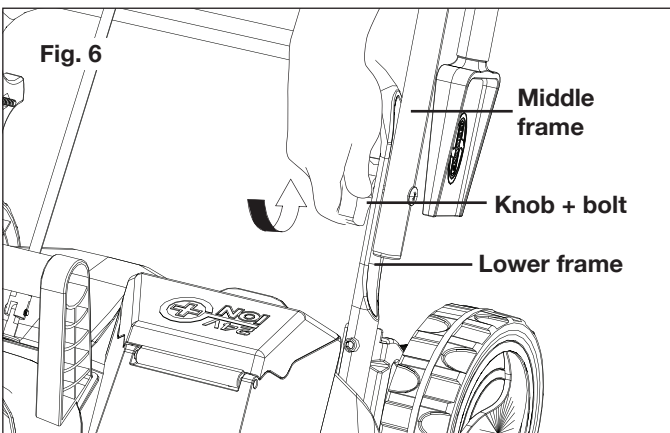

3. Secure the connection of the upper frame to the middle frame by fastening the second set knobs and bolts on each side (Fig. 7).

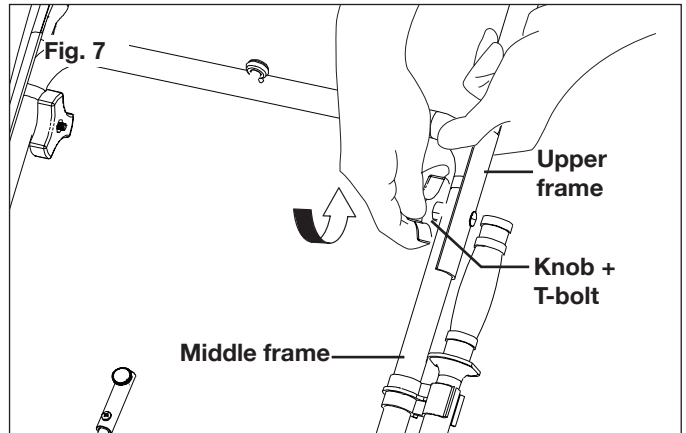

Discharge Chute Assembly

1. Loosen the chute deflector knob to lift the chute deflector (Fig. 8).

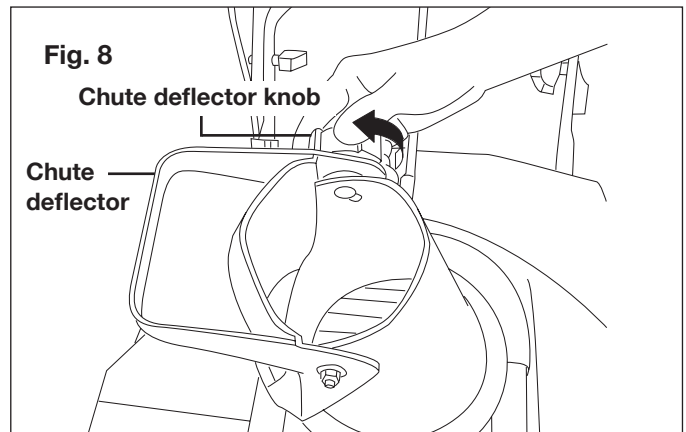

2. Lift the chute deflector and lock it securely onto the discharge chute (Fig. 9).

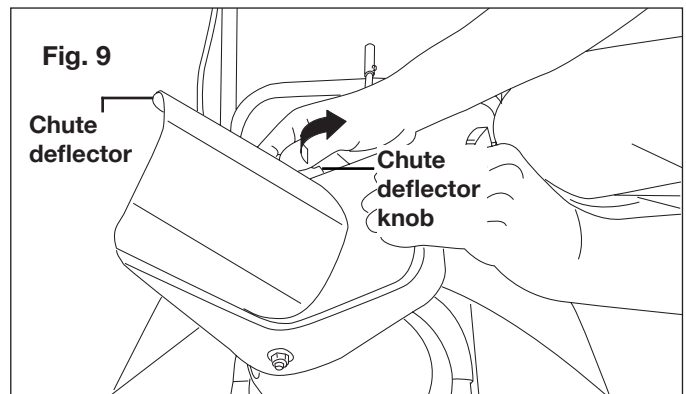

3. Raise or lower the chute deflector to the desired height of the snow stream and tighten the chute deflector knob (Fig. 9).

NOTE: Do not overtighten the chute deflector knob.

Chute Crank Assembly

1. Slide the upper chute crank through the rubber ring located on the middle frame (Fig. 10).

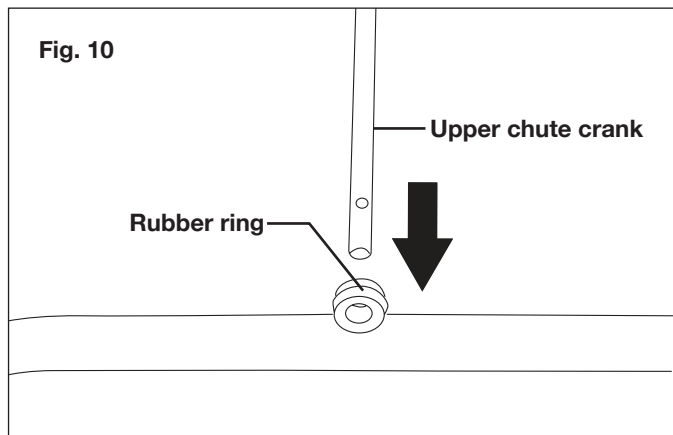

2. Loosen the screw on the lower chute crank by hand (Fig. 11).

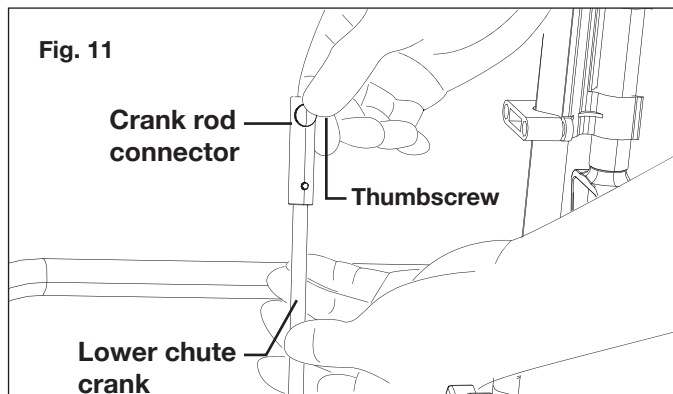

3. Slide the upper chute crank into the lower chute crank (Fig. 12).

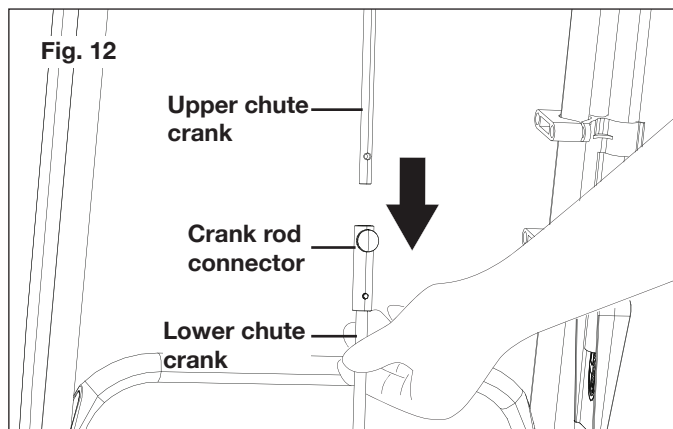

4. Align the screw holes and tighten the screw by hand (Fig. 13).

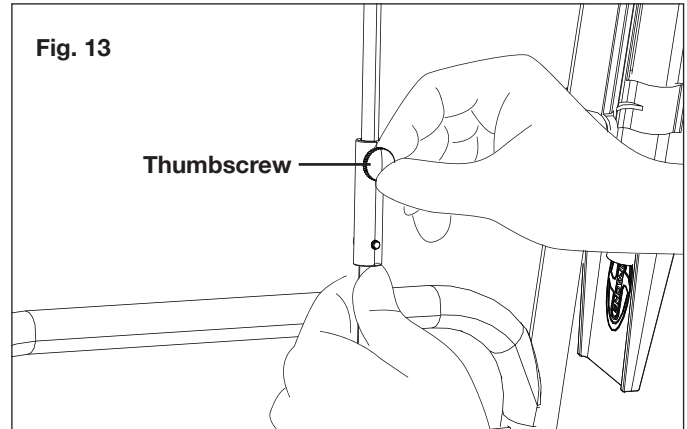

Operation

⚠️ WARNING! Keep the area to be cleared free of stones, toys or other foreign objects that the rotor blades might pick up and throw. Such items could be covered by snow and are easy to overlook, so be sure to conduct a thorough inspection of the area before beginning work.

Starting + Stopping

1. Open the battery compartment covers and slide each battery down until it clicks to lock it into position (Fig. 14).

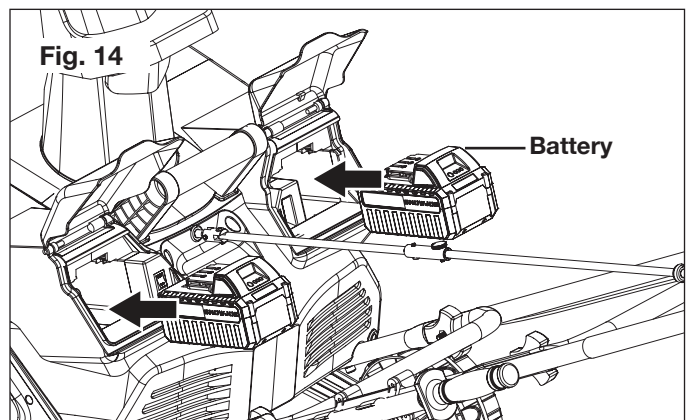

2. Insert the safety key into the slot and close the battery compartment cover (Figs. 15).

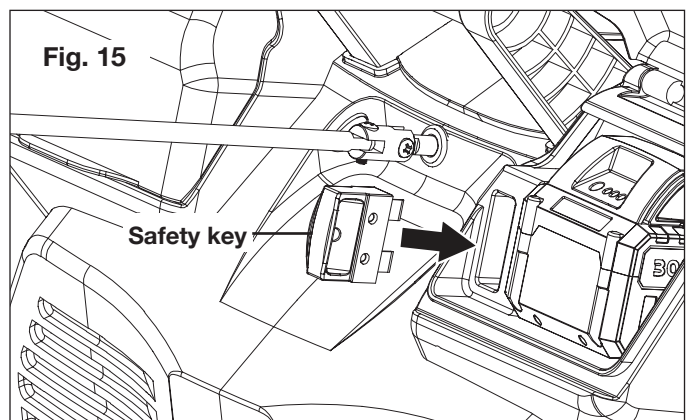

3. While depressing the safety switch button, pull the ON/OFF trigger toward you. Once the machine powers on, release the safety switch button and begin operation (Fig. 16). The machine can only be started by depressing the safety switch button first, followed by squeezing the ON/OFF trigger; reverse operation will not start the machine.

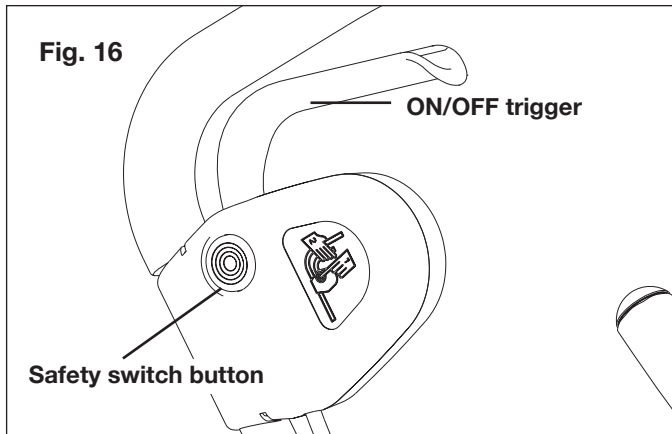

4. To power off, release your grip on the ON/OFF trigger.

Operating Tips

⚠️ WARNING! Foreign objects, such as rocks, broken glass, nails, wire, or string, can be picked up and thrown by the snow blower, causing serious personal injury. Remove all foreign objects from the area to be plowed before operating the snow blower.

1. Keep the area of operation free of foreign objects that can become thrown by the rotor blades. Perform a thorough inspection of the area since some objects may be hidden from view by surrounding snow. If the snow blower hits an obstruction or picks up a foreign object during use, stop the snow blower, remove the batteries, remove the obstruction, and inspect the unit for damage. Repair or replace any damaged part before restarting and operating the unit.
2. Keep children, pets, and bystanders away from the area of operation. Be aware that the normal noise of the machine when turned on may make it difficult for you to hear approaching people.
3. When moving the snow blower, use the wheels on one side as the pivot point. Slightly tilt the snow blower on this pivot point to move it forward or backward.
4. Start your clearing path outward, throwing snow in a back and forth motion. To clear in the opposite direction, pivot the snow blower on its wheels. Make sure to overlap clearing paths.
5. Note the wind direction. If possible, move in the same direction as the wind so that the snow is not thrown against the wind (and thus back into your face and on the just cleared path).
6. Do not push the snow blower with excessive force. You should push the machine gently and evenly in accordance with the unit's throw rate.

7. Do not apply additional man-made load to the motor since this may cause motor damage.
8. Some parts of the snow blower may freeze under extreme temperature conditions. Do not attempt to operate the snow blower with frozen parts. If the parts freeze while the snow blower is in use, stop the snow blower, remove the batteries, and inspect for frozen parts. Free all parts before restarting or operating the snow blower. Never force controls that have frozen.
9. When working on pebbles, gravel, or unpaved surfaces, avoid throwing loose surface material along with the snow by pushing down on the handle to raise the scraper at the base of the unit above the pebbles or gravel.

Headlight

The snow thrower is equipped with a headlight that can be used to illuminate the forward path in the dark. To use the light, turn on the light switch located on the back side next to the battery compartment on the left (Fig. 17).

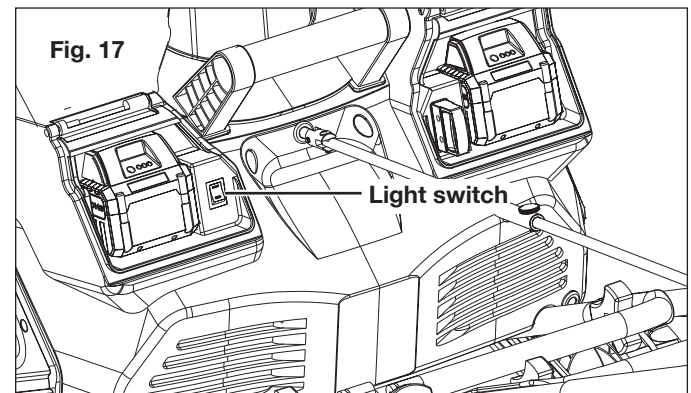

NOTE: The lights will only turn ON when the snow thrower is running. After finishing your work session, REMEMBER to TURN OFF the light switch.

Changing Throw Direction and Throw Height



WARNING



Never direct the snow discharge chute at the operator, at bystanders, at vehicles, or at nearby windows. The discharged snow and foreign objects accidentally picked up by the snow thrower can cause serious damage and personal injury.

Always orient the discharge chute in the opposite direction from where you, bystanders, surrounding vehicles, or windows are located.

1. The discharge chute can be adjusted 180 degrees by rotating the chute crank. Rotate the chute control crank clockwise to move the discharge chute to the left and counterclockwise to move the chute to the right (Fig. 18).

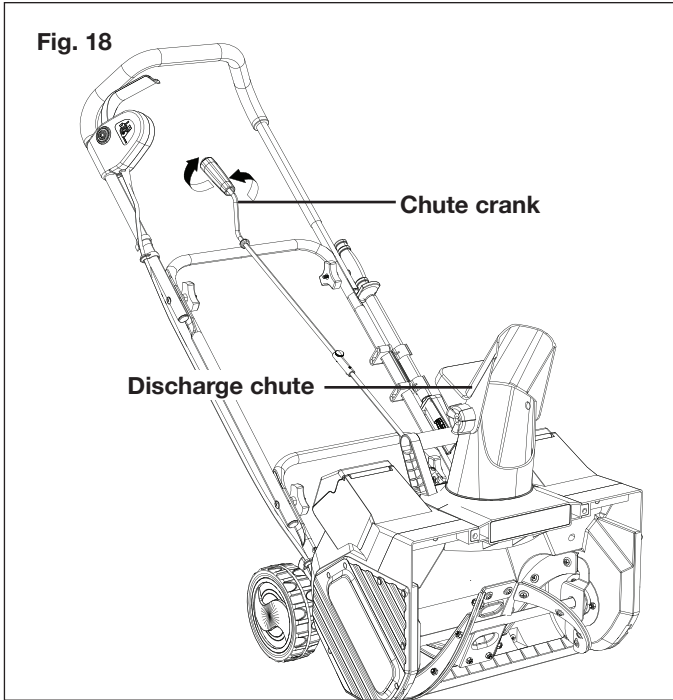

2. The chute deflector on the top of the discharge chute controls the height of the snow stream. Loosen the knobs to raise or lower the deflector to the desired height of snow you wish to throw. Tighten the knobs to secure the deflector (Fig. 19).

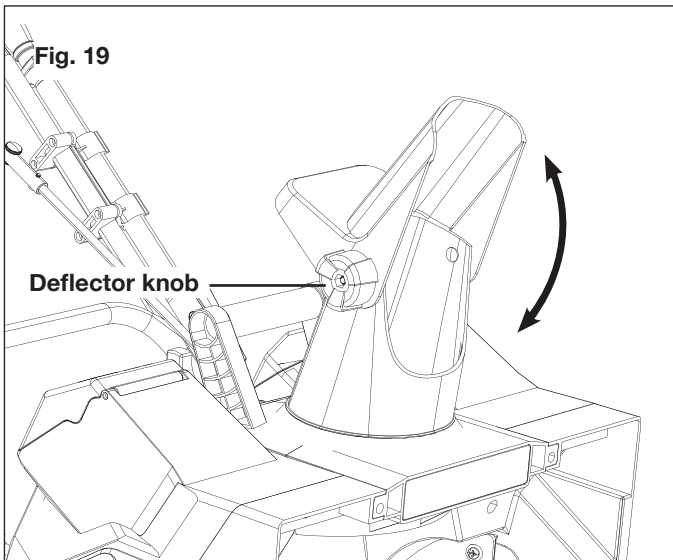

WARNING



Make sure that the chute deflector snaps and locks completely onto the discharge chute. An opening between the discharge chute and the chute deflector may allow foreign objects to be picked up by the snow thrower and thrown in the direction of the operator causing serious bodily injury.

- Do not advance the chute deflector too far forward causing an opening to appear between the deflector and discharge chute.
- Do not overtighten the knobs on the chute deflector.

Maintenance

To order genuine replacement parts or accessories for the Snow Joe® 24V-X2-SB18 cordless snow blower, please visit snowjoe.com or contact the Snow Joe® + Sun Joe® customer service center at 1-866-SNOWJOE (1-866-766-9563).

⚠️ WARNING! Make sure to turn off the switch and remove the batteries before performing any maintenance task on your snow blower.

Lifetime Lubrication (Motor + Auger)

Lubrication is not necessary and may damage the unit. The snow blower is lubricated for lifetime use at the factory before shipment.

General Maintenance Tips

1. Do not attempt to repair the machine unless you have the proper tools and instructions for disassembly and repair of the machine.
2. Check bolts and screws at frequent intervals for proper tightness to ensure that the equipment is in safe working condition.
3. After each snow removal session, run the snow blower for a few minutes to prevent the collector/impeller from freezing. Shut off the motor, wait for all revolving parts to stop completely, and wipe residual ice and snow off the unit. Rotate the chute deflector by the chute control crank several times to remove any excess snow.

Proper Care for Batteries + Charger

⚠️ WARNING! To reduce the risk of injury, always unplug the charger and remove the battery packs from the charger before performing any maintenance task. Never disassemble the battery packs or charger. Contact your Snow Joe® + Sun Joe® dealer or the Snow Joe® + Sun Joe® customer service center for ALL repairs.

1. To reduce the risk of injury and damage, never immerse your battery packs or charger in liquid or allow any liquid to flow inside these components.
2. Clean out dust and debris from charger vents and electrical contacts by blowing with compressed air.
3. Use only mild soap on a damp cloth to clean the battery packs and charger, keeping away from all electrical contacts. Certain cleaning agents and solvents are harmful to plastics and other insulated parts. Some of these include gasoline, turpentine, lacquer thinner, paint thinner, chlorinated cleaning solvents, ammonia and household detergents containing ammonia. Never use flammable or combustible solvents around battery packs, battery chargers or tools.
4. The 24V iON+ lithium-ion battery charger has no serviceable parts.

Maintenance + Storage

1. Run the machine a few minutes after throwing snow to prevent the auger from freezing.
2. Examine the cordless snow blower thoroughly for worn, loose or damaged parts. Should you need to repair or replace a part, contact an authorized Snow Joe® + Sun Joe® dealer or call the Snow Joe® + Sun Joe® customer service center at 1-866-SNOWJOE (1-866-766-9563) for assistance.
3. Clean the snow blower before storing or transporting. Be sure to secure the unit while transporting.
4. Remove the batteries and the safety key from the cordless snow blower before storing.
5. Store the cordless snow blower indoors in a locked, dry place out of the reach of children to prevent unauthorized use or damage.
6. Maintain safety and instruction labels, as necessary.
7. Always refer to the Battery + Charger Off-Season Storage section for important details if the snow thrower is to be stored for an extended period.

Battery + Charger Off-Season Storage

1. Do not expose your battery packs or charger to water, rain or allow them to get wet. This could permanently damage the charger and the battery packs. Do not use oil or solvents to clean or lubricate your battery packs as the plastic casing can become brittle and crack, causing a serious risk of injury.
2. Store the battery packs and charger at room temperature away from moisture. Do not store in damp locations where corrosion of terminals may occur. As with other battery pack types, permanent capacity loss can result if the pack is stored for long periods of time at high temperatures (over 120°F/49°C).
3. 24V iON+ lithium-ion battery packs maintain their charge during storage longer than other battery pack types. As a general practice, it is best to unplug the battery charger and remove the battery packs when they are not in use. Recharge the battery packs every 6 months to 50% capacity (2 lights on) during off-season storage to maintain optimal battery performance.

Battery Caution + Disposal Information

Always dispose of your battery packs according to federal, state, and local regulations. Contact a recycling agency in your area for recycling locations.

⚠ CAUTION! Even discharged battery packs contain some energy. Before disposing, use electrical tape to cover the terminals to prevent the battery packs from shorting, which could cause a fire or explosion.

⚠ WARNING! To reduce the risk of injury or explosion, never burn or incinerate battery packs even if it is damaged, dead or completely discharged. When burned, toxic fumes and materials are emitted into the surrounding atmosphere.

1. Batteries vary according to device. Consult your manual for specific information.

2. Install only new batteries of the same type in your product (where applicable).
3. Failure to insert batteries in the correct polarity, as indicated in the battery compartment or manual, may shorten the life of the batteries or cause batteries to leak.
4. Do not mix old and new batteries.
5. Do not mix Alkaline, Standard (Carbon-Zinc) or Rechargeable (Nickel Cadmium, Nickel Metal Hydride, or Lithium-Ion) batteries.
6. Do not dispose of batteries in fire.
7. Batteries should be recycled or disposed of as per state and local guidelines.

Service + Support

If your Snow Joe® 24V-X2-SB18 cordless snow blower requires service or maintenance, please call the Snow Joe® + Sun Joe® customer service center at 1-866-SNOWJOE (1-866-766-9563).

Model + Serial Numbers

When contacting the company, reordering parts or arranging service from an authorized dealer, you will need to provide the model and serial numbers, which can be found on the decal located on the housing of the unit. Copy these numbers into the space provided below.

Record the following numbers from the housing or handle of your new product:

Model #:



2	4	V	-	X	2	-	S	B	1	8										
---	---	---	---	---	---	---	---	---	---	---	--	--	--	--	--	--	--	--	--	--

Serial #:

--	--	--	--	--	--	--	--	--	--	--	--	--	--	--	--	--	--	--	--	--	--

Accessories

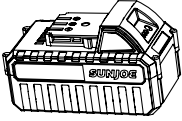
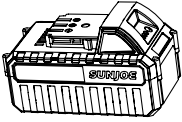
⚠️ WARNING! ALWAYS use only authorized Snow Joe® + Sun Joe® replacement parts and accessories. NEVER use replacement parts or accessories that are not intended for use with this cordless snow blower. Contact Snow Joe® + Sun Joe® if you are unsure whether it is safe to use a particular replacement part or accessory with your cordless snow blower. The use of any other attachment or accessory can be dangerous and could cause injury or mechanical damage.

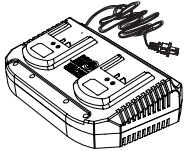
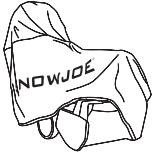
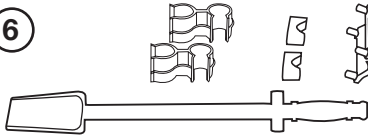
Accessories	Item	Model
	24V iON+ 4.0 Ah Lithium-Ion Battery <i>Battery Charge Time Max:</i> 24VCHRG-AC: 2 hrs 40 min 24VCHRG-QC: 1 hr 50 min 24VCHRG-DPC: 1 hr 50 min <i>Battery Runtime Max: 40 mins</i>	24VBAT
	24V iON+ 5.0 Ah Lithium-Ion Battery <i>Battery Charge Time Max:</i> 24VCHRG-AC: 3 hrs 20 min 24VCHRG-QC: 2 hr 20 min 24VCHRG-DPC: 2 hr 20 min <i>Battery Runtime Max: 50 mins</i>	24VBAT-XR
	24V iON+ Lithium-Ion Battery Quick Charger	24VCHRG-QC
	24V iON+ Lithium-Ion Battery Dual Port Charger	24VCHRG-DPC
	Universal 21-inch snow thrower protection cover	SJCVR-21
	Universal Snow Thrower Chute Clean-Out Tool	SJCOT

NOTE: Accessories are subject to change without any obligation on the part of Snow Joe® + Sun Joe® to provide notice of such changes. Accessories can be ordered online at snowjoe.com or via phone by contacting the Snow Joe® + Sun Joe® customer service center at 1-866-SNOWJOE (1-866-766-9563).

NOTES



SNOW JOE® + SUN JOE® CUSTOMER PROMISE

ABOVE ALL ELSE, Snow Joe® + Sun Joe® are dedicated to you, our customer. We strive to make your experience as pleasant as possible. Unfortunately, there are times when a product does not work or breaks under normal operating conditions. We think it's important that you know what you can expect from us. That's why we created the Snow Joe® + Sun Joe® promise.

OUR PROMISE: Snow Joe® + Sun Joe® warrant new products for two years from the date of purchase. If your product does not work, or there's an issue with a specific part, we will fix this by either sending you a free replacement part or by sending you a new or comparable product at no charge. How cool is that! Before you know it, you'll be back in action cutting, sawing, mowing, washing and...?

PRODUCT REGISTRATION:

Snow Joe®, LLC ("Snow Joe® + Sun Joe®") strongly encourages you to register your purchase. You can register online at snowjoe.com/ProductRegistration, or by printing and mailing in a registration card available online from our website, or calling our Customer Service Department at **1-866-SNOWJOE (1-866-766-9563)**, or by e-mailing us at help@snowjoe.com. Failure to register your product purchase will not diminish your warranty rights. However, registering your purchase will allow Snow Joe® + Sun Joe® to better serve you with any of your customer service needs.

WHO CAN SEEK WARRANTY COVERAGE?

This Warranty is extended by Snow Joe® + Sun Joe® to the owner of this Machine (a "Machine" consists of a product powered by a motor) for residential and personal household use only. This Warranty does not apply to products used for commercial, rental or re-sale purposes. Should ownership of this machine change during the 2-year period, please update the Machine's owner information at snowjoe.com/ProductRegistration.

WHAT IS COVERED?

Snow Joe® + Sun Joe® warrants to the owner that if this Machine fails within 2 years from the date of purchase due to a defect in material or workmanship or as a result of normal wear and tear from ordinary household use, Snow Joe® + Sun Joe® will send a replacement part or product, as needed, free of charge and with free shipping to the original purchaser.

If, in Snow Joe® + Sun Joe®'s sole discretion, the failed Machine cannot be repaired with a part, Snow Joe® + Sun Joe® will elect to either (A) send a new Machine at no charge and with free shipping or (B) refund the full purchase price to the owner.

WHAT IS NOT COVERED?

This Warranty does not apply to the Machines that have been used commercially or in non-household applications. This Warranty does not cover cosmetic changes that do not affect performance. This Warranty is only valid if the Machine is used and maintained in accordance with the instructions, warnings and safeguards contained in the owner's manual. Snow Joe® + Sun Joe® will not be responsible for the cost of any unauthorized warranty repairs. This warranty does not cover any cost or expense incurred by the purchaser in providing substitute equipment or service during reasonable periods of malfunction or non-use of this product while waiting for a replacement part or unit under this warranty.

Wearing parts like belts, augers, chains and tines are not covered under this warranty, and can be purchased at snowjoe.com or by calling **1-866-SNOWJOE (1-866-766-9563)**. Batteries are covered in full for 90-days from the date of purchase.

Repair, replacement or refund of the purchase price are the exclusive remedies of purchaser and the sole liability of Snow Joe® + Sun Joe® under this warranty. No employee or representative of Snow Joe® + Sun Joe® is authorized to make any additional warranty or any modification to this warranty which may be binding upon Snow Joe® + Sun Joe®. Accordingly, purchaser should not rely upon any additional statements made by any employee or representative of Snow Joe® + Sun Joe®. In no event, whether based on contract, indemnity, warranty, tort (including negligence), strict liability or otherwise, shall Snow Joe® + Sun Joe® be liable for any special, indirect, incidental, or consequential damages, including, without limitation, loss of profit or revenue.

Some states do not allow limits on warranties. In such states, the above limitations may not apply to you.

Outside the USA, other warranties may apply.



snowjoe.com